

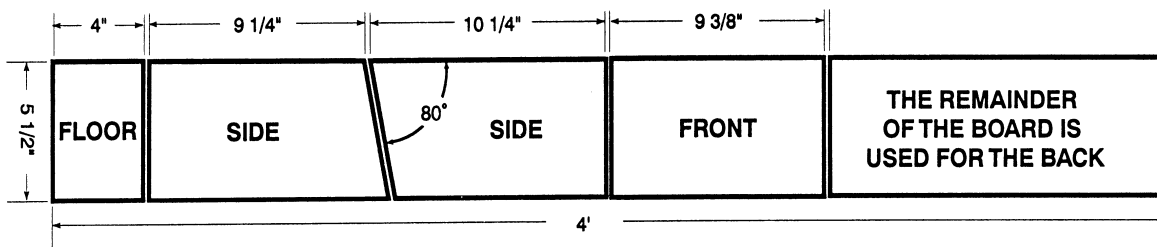

The North American Bluebird Society Children's Eastern Bluebird Nest Box

MATERIALS LIST

- STANDARD 1" x 6" - 4 FEET LONG
- STANDARD BOARD 1" x 10" - 10 1/2" LONG
- 1 3/4" GALVANIZED NAILS - APPROX. 20
- 1 3/4" GALVANIZED SCREW FOR PIVOT POINT - 2
- DOUBLE HEADED NAIL FOR HOLDING DOOR CLOSED - 1

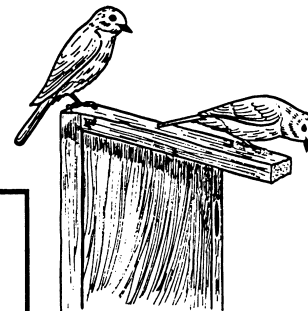
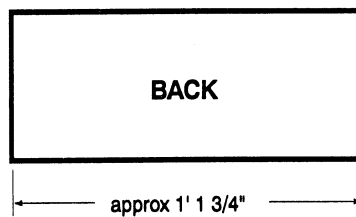
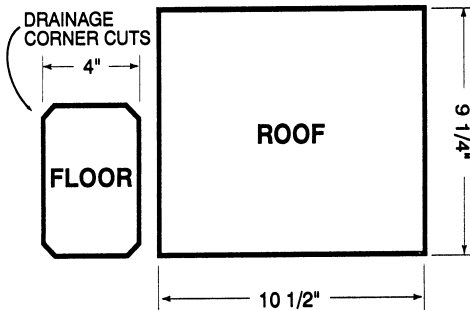
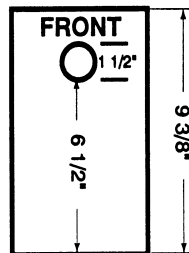
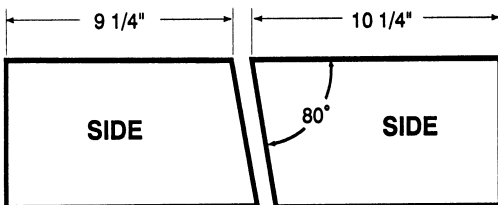
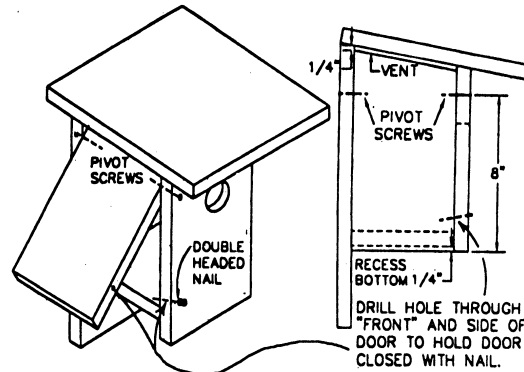
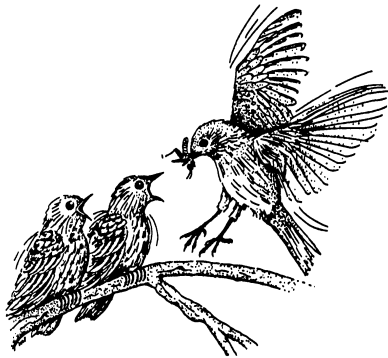

For membership information, send a note and a self-addressed, stamped envelope to: North American Bluebird Society, P. O. Box 74, Darlington, WI 53530-0074. For questions send e-mail to: nabluebird@aol.com or visit NABS' website at <http://www.cobleskill.edu/nabs/>